



WORK ORDER

DELIVERY DUE DATE: 18 OCT 2024

Procurement Unit
Tel No.: 045-606-8142/606-8157

Supplier : **PROGRESS HOME AND OFFICE FURNISHINGS**
Address : 73 Panay Ave., Brgy. Paligsahan, Quezon City
TIN: 002-884-643-009 VAT Reg.
Tel. No. : (02) 8374-5411 to 13

Work Order No.: 2024-156 ✓
Date : 5/23/2024 ✓
JO No. : 2023-292 ✓
Date : 10/20/2023 ✓
Mode of Procurement: Public Bidding ✓
Mode of Payment: N/30 ✓

SIR/MADAM:

You are hereby advised to accomplish/deliver the following job/work within **One Hundred Twenty (120) calendar days** upon receipt of the Notice of Award as per quotation submitted by you duly approved by the TSU Committee on Bids and Awards and the President of the Agency

QTY.	UNIT	DESCRIPTION	UNIT COST	TOTAL COST
1	lot	<p>NEGOTIATED PROCUREMENT FOR THE PROJECT SUPPLY, DELIVERY, AND FABRICATION OF DRAFTING TABLES FOR THE COLLEGE OF ARCHITECTURE AND FINE ARTS</p> <p>DRAFTING TABLES, made of the tabletop wood and metal framing; Tabletop: 600mm x 900mm x 3/4 thk ply board with laminated tabletop (please provide available swatches); wood edging (2x1); Metal Framing: 1" Dia. G.I. pipe Gauge #20 with 3/4" Dia. G.I pipe for the support Frame. For its Leg base with a provision of rubber Base. powder coated finished; Color: black; Drawer/storage is fixed.</p> <p>*** Please see attached Layout</p> <p>*****</p>	1,389,000.00	<u>1,389,000.00</u>



(Please read carefully at the back hereof)

Charge to: 06-704441
ROA No. : 2024-06-016
CONFORME & RECEIVE COPY :

ALEXANDRO S. DELA TORRE JR.
PROGRESS HOME AND OFFICE FURNISHINGS

Firm/Dealer/Supplier/Contractor

6-10-24
Date

Bank Account Name: _____

FUNDS AVAILABLE:

JASPER A. YAUDER, CPA

Budget Office

APPROVED:

DR. ARNOLD E. VELASCO

FORMICA TABLETOP (WHITE)

1 X 2 S4S KD WOOD EDGING

600 mm

900 mm

1 X 1/2 WOOD EDGING

3/4" THY PLYWOOD

1020 mm

2 X 1 LISTON
OR WOOD EDGING

250 mm

670

2 X 3 X 3/16" FLATBAR
WITH WOODEN
SCREW (TYPICAL)

3/4" DIA G.I. PIPE
1" DIA G.I. PIPE

RUBBER BASE

840 mm

740 mm

100 mm

700 mm

518 mm

I hereby certify to comply and deliver all the above Technical Specifications and requirements:

Progress Home & Office Furnishings / Verde Linear Corporation

Name of Company / Bidder

Date: March 5, 2024

ALEJANDRO S. SHILA TORRE JR.

Bidder's Authorized Representative

ISOMETRIC VIEW
SCALE 1:1.0M

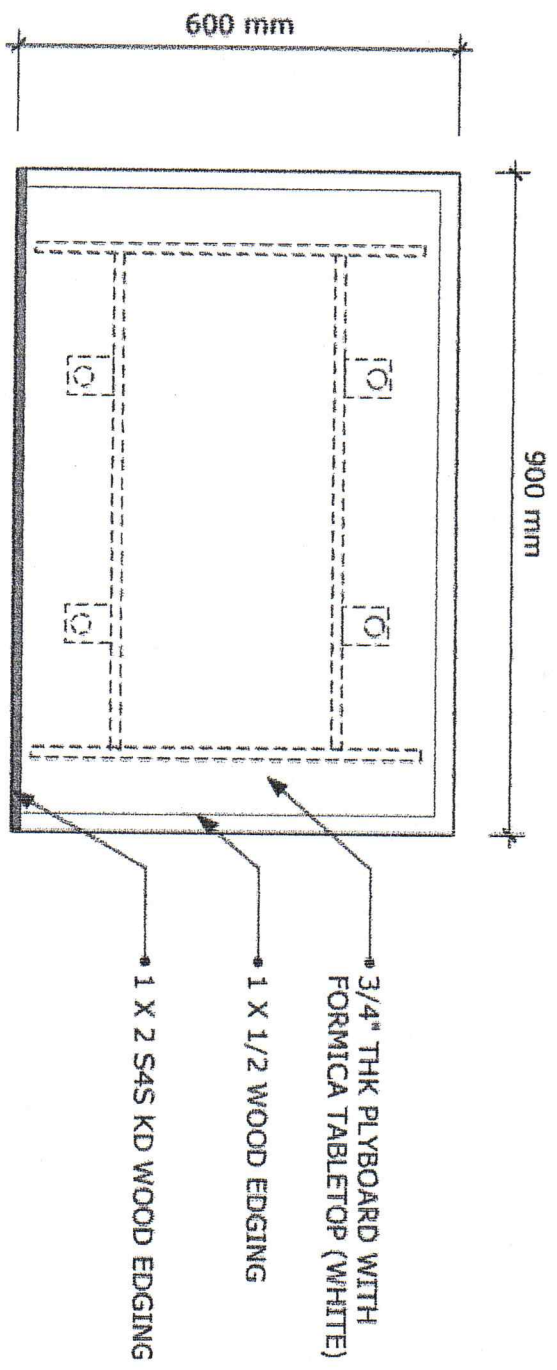

TOP VIEW
SCALE 1:10M

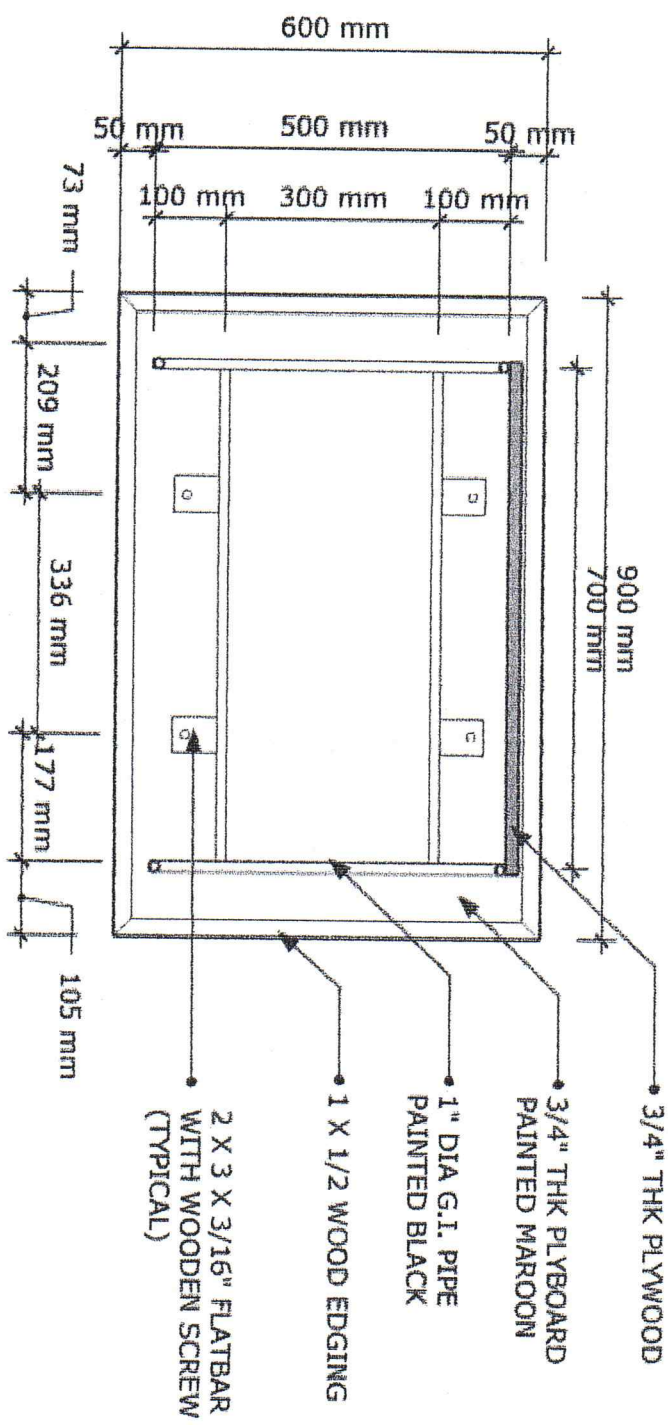

BOTTOM VIEW
SCALE 1:10M

I hereby certify to comply and deliver all the above Technical Specifications and requirements:

Progress Home & Office Furnishings / Verde Linear Corporation
Name of Company / Bidder
Date: March 5, 2024

ALEJANDRO DELA TORRE JR.
Bidder's Authorized Representative

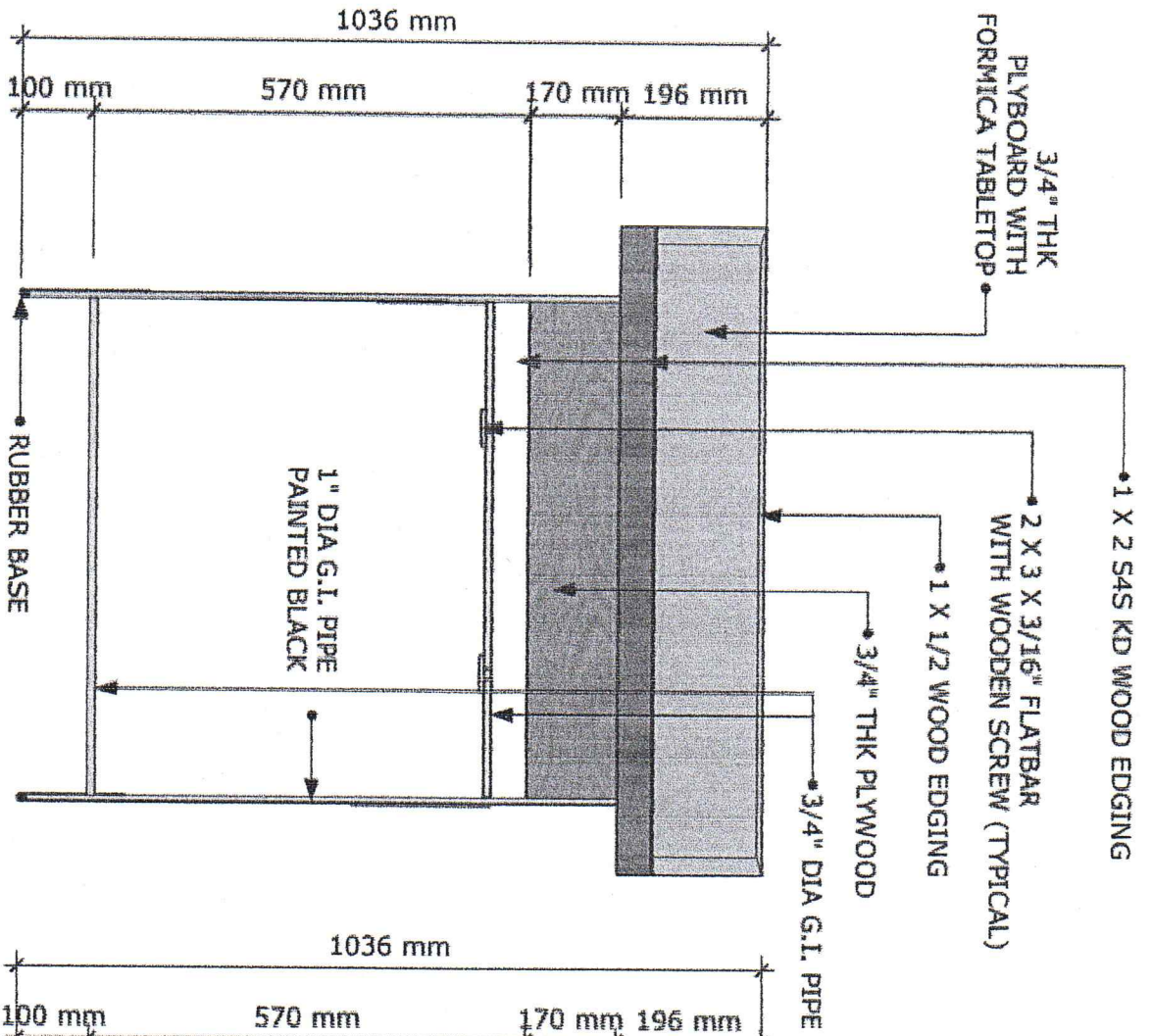

FRONT VIEW
SCALE 1:10M

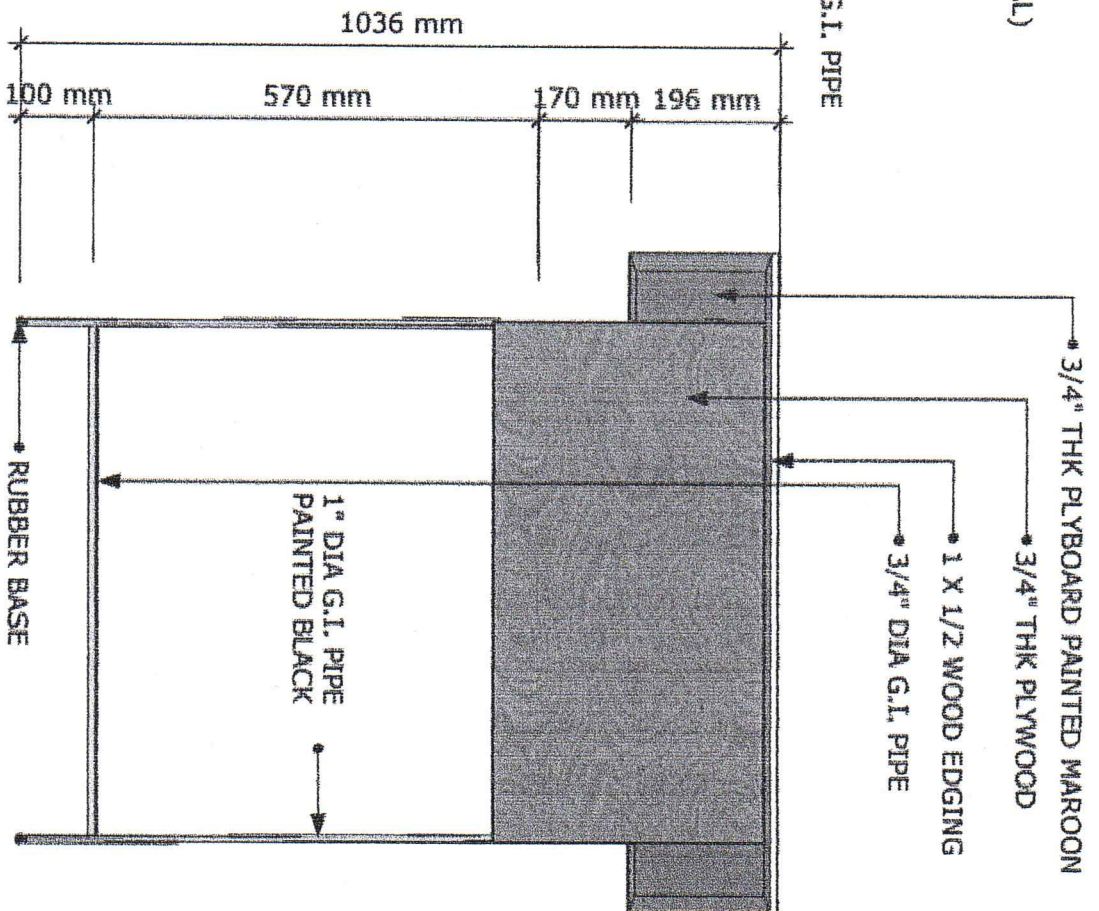

REAR VIEW
SCALE 1:10M

I hereby certify to comply and deliver all the above Technical Specifications and requirements.

Progress Home & Office Furnishings / Verde Linear Corporation
Name of Company / Bidder
Date: March 5, 2024

ALEXANDRO E. DELA TORRE JR.
Bidder / Authorized Representative

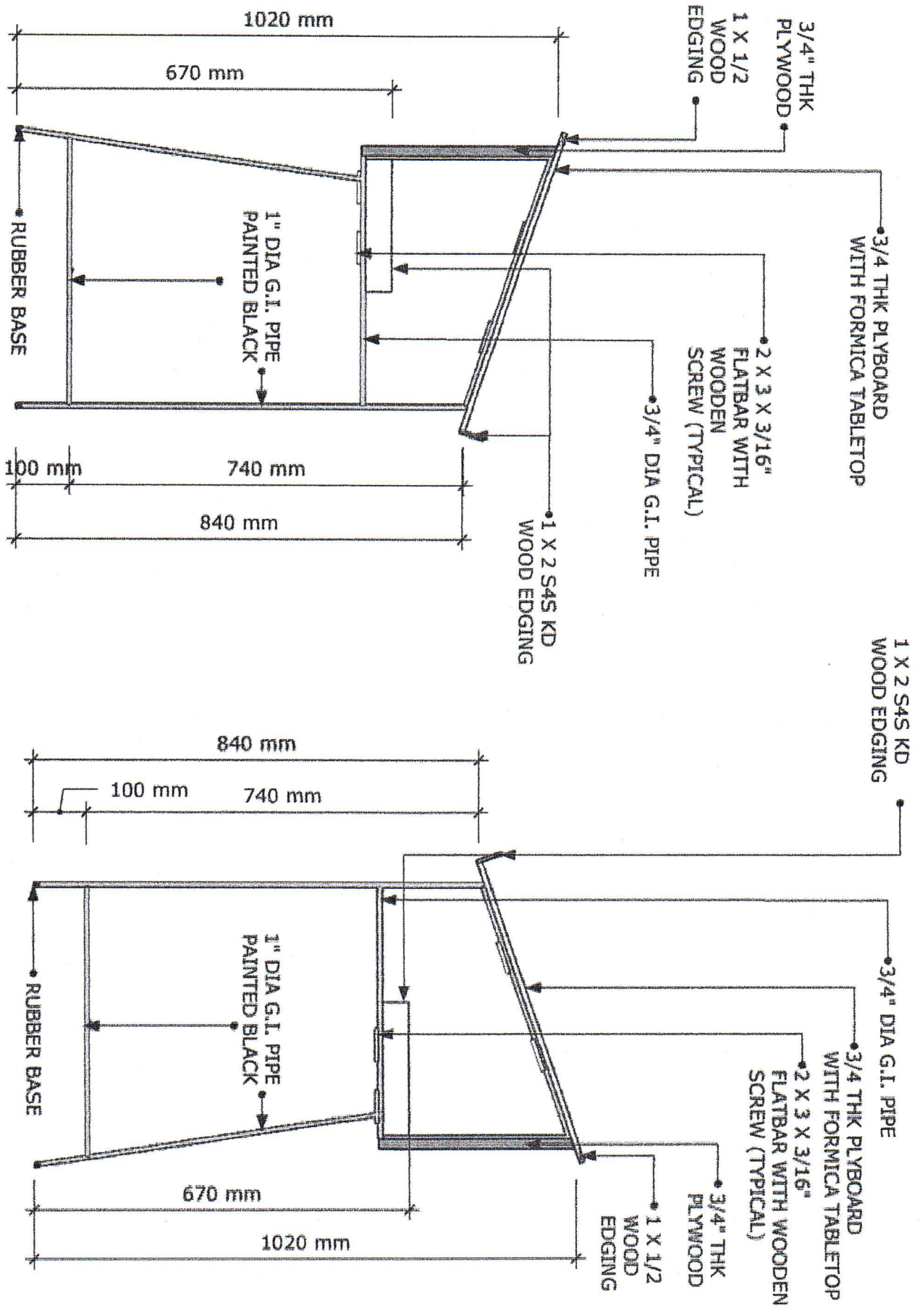

LEFT SIDE VIEW

SCALE 1:10M

RIGHT SIDE VIEW

SCALE 1:10M

I hereby certify to comply and deliver all the above Technical Specifications and requirements

Progress Home & Office Furnishings / Verde Linear Corporation
Name of Company / Bidder

ALEJANDRO E. DETA TORRE JR.
Bidder's Authorized Representative

Date: March 5, 2024

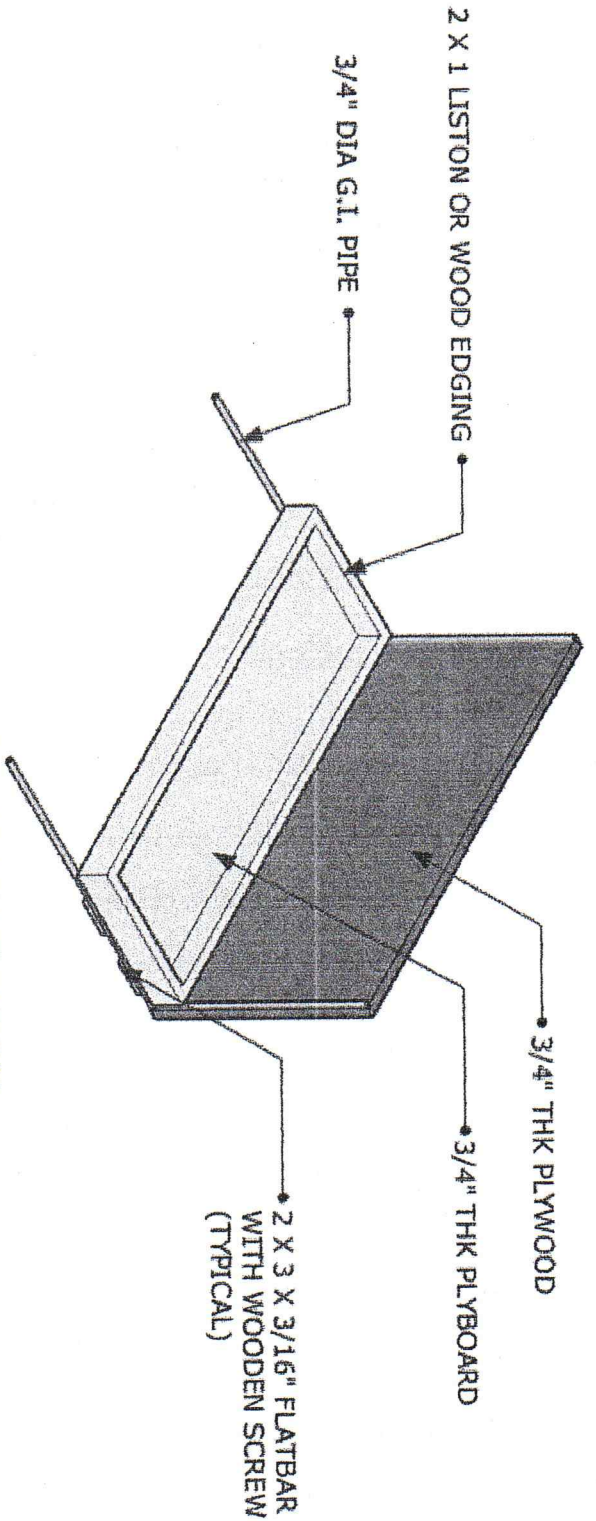

STORAGE 2 ISOMETRIC VIEW
SCALE 1:10M

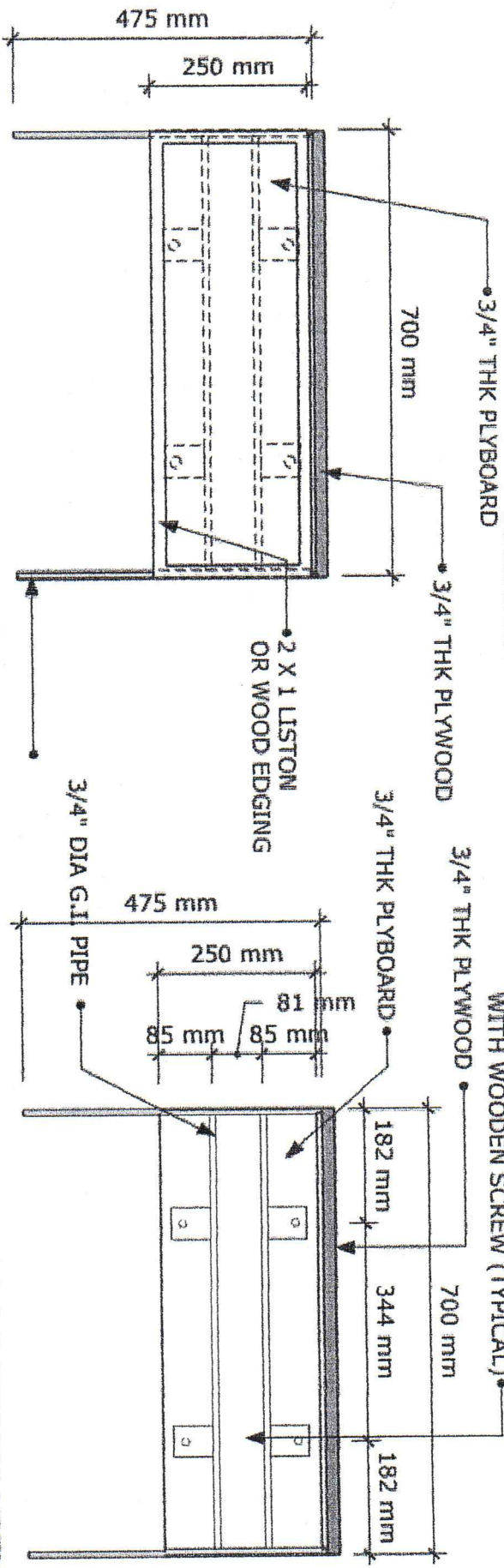

STORAGE 2 TOP VIEW
SCALE 1:10M

STORAGE 2 BOTTOM VIEW
SCALE 1:10M

I hereby certify to comply and deliver all the above Technical Specifications and requirements.

Progress Home & Office Furnishings / Verde Linear Corporation

ALEJANDRO CARIELA TORRE JR.
Bidder / Authorized Representative

Date: March 5, 2024